

**LESSO**<sup>®</sup> America



## PVC Schedule 80 Fittings



SABAH DISTRIBUTOR:

KEKALBOLEH SDN BHD  
(199901021248/496148-K)  
Lot No. 7, Lorong Perindustrian Kolombong Jaya,  
Pusat Perindustrian Kolombong Jaya,  
Mile 5.5, Jalan Kolombong,  
88450 Kota Kinabalu, Sabah.  
Tel/WhatsApp: 088-385555 / 013-8867570  
Website: kekalboleh.com

LESSO AMERICA, INC.



LESSO Headquarter



LESSO Research Institute & Testing Center



LESSO College



Training Apartment

## China LESSO Group Holdings Limited

China Lesso Group Holdings Limited (HKEx, stock name: China Lesso, stock code: 2128) is a large industrial group of home building materials in China. China Lesso's products and services cover plumbing products, sanitary ware, holistic kitchen, PVC profile doors and windows, decorative plates, fire-fighting equipment, hygiene materials, ocean aquaculture cages, environmental protection, home furnishing and building material one-stop O2O services, etc. The sales revenue had broken through 2.5 billion dollars in 2016.

With the rapid global development of its businesses, China Lesso has more than 50 holding subsidiaries and more than 22 production bases distributed in 16 provinces of Mainland China, US, Canada, India, Indonesia and Uganda. China Lesso has continually perfected its strategic layout and broadened its sales network and market, to provide products and services to customers in a timely and efficient way.

China Lesso established an international R&D center, which includes a post-doctoral workstation, and China National Accredited Laboratories authorized by CNAS. Our research team has a staff of more than one thousand. At present, China Lesso owns more than 1,800 patents (some of them are under processing). Our products are awarded successively of National Torch Plan Projects, National Key New Product, Scientific

Achievements Promotion Projects in National Construction Industry and Government Green Procurement List; and also has been awarded many honorary titles, such as National High-Tech Enterprise, National Certified Enterprise Technology Center, China Construction Independent Innovation of Science Superior Enterprise, Intellectual Property Right Preponderant Enterprise, Demonstrational Construction Base of Plastic Piping High Tech Industrialization of Ministry of Urban and Rural Development, Guangdong Provincial Government Quality Prize, etc.

China Lesso offers a comprehensive range of products in the domestic home building materials area which includes more than 10,000 specifications. The products are being widely used in the areas of home decoration, civil construction, municipal water supply, drainage, electric power communication, gas supply, fire-fighting, environmental protection, agriculture, and oceanic cageculture, etc.

True to its mission of "Creating a Relaxing Life", China Lesso is committed to becoming a world-class conglomerate in the broader home building materials sector, as a manufacturer that provides customers with products and services of outstanding price-performance and helps build homes of quality and comfort.



## QUALITY

LESSO America's plastic fittings line is renowned worldwide for its superior quality, which complies with cNSFus certifications, and the requirements of ASTM standards and CSA standards.

## REFERENTIAL STANDARDS (Schedule 80 )

NSF/NASI 61 Drinking Water System Components-Health Effects

NSF/NASI 14 Plastics Piping System Components and Related Materials

ASTM D 1784 Standard Specification for Rigid Poly (Viny Chloride) (PVC) Compounds and Chlorinated Poly (Viny Chloride) (CPVC) Compounds

ASTM D 2467 Standard Specification for Rigid Poly (Viny Chloride) (PVC) Plastic Pipe Fittings, Schedule 80

ASTM F 1970 Standard Specification for Special Engineered Fittings, Appurtenances or Valves for use in Poly (Viny Chloride) (PVC) or Chlorinated Poly (Viny Chloride) (CPVC) Systems

CSA B137.3 Rigid Polyvinylchloride (PVC) Pipe and Fittings for Pressure Applications.

# Contents

Column Header Information .....	01
Methods Of Designating Inlets Of Fittings ..	01
PVC Schedule 80 Fittings .....	02-05
Limited Warranty .....	06
Terms And Conditions Of Sale .....	07

## COLUMN HEADER INFORMATION

Each product column header label identifies the following product particulars:

**Part Number:** the number used to order the part.

**Size:** nominal diameter of pipe with which the fitting is to be used.

**NOTE:** Fittings may be same size (only one size designation) or reducing (multiple sizes designated).

Standard Pack (Std Pk) the quantity of parts packaged in an individual box or bag.

Master Carton (Mstr Ctn) the total quantity of parts contained in individual boxes or bags which are packaged together.

## METHODS OF DESIGNATING INLETS OF FITTINGS

### PVC SCHEDULE 80 FITTINGS

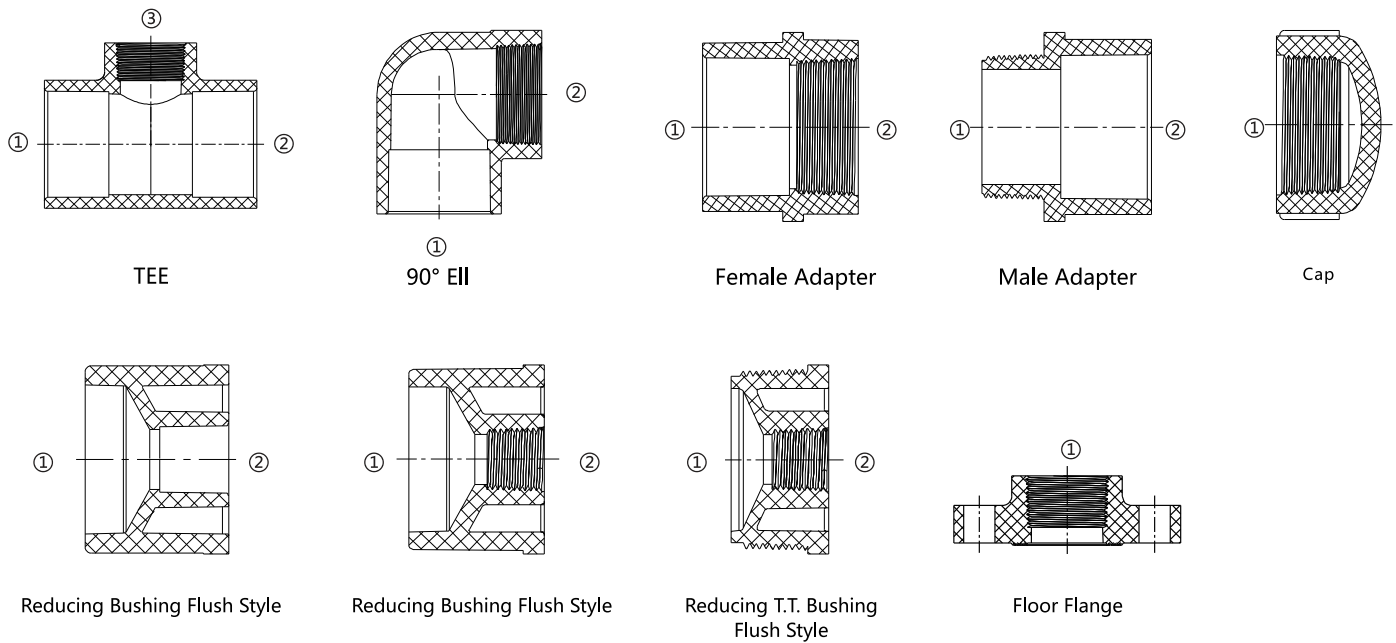

TEE (SOC × SOC × SOC)

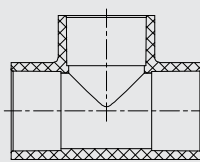

Part Number	Size (in)	Std PK	Mstr Ctn
801-002	1/4	50	600
801-005	1/2	25	200
801-007	3/4	15	120
801-010	1	20	80
801-012	1-1/4	10	40
801-015	1-1/2	5	30
801-020	2	5	20
801-025	2-1/2	10	0
801-030	3	5	0
801-040	4	5	0
801-060	6	2	0
801-080	8	5	0

TEE (FIPT × FIPT × FIPT)

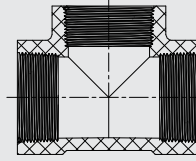

Part Number	Size (in)	Std PK	Mstr Ctn
805-002	1/4	50	600
805-003	3/8	50	400
805-005	1/2	20	240
805-007	3/4		
805-010	1	15	90
805-012	1-1/4	10	40
805-015	1-1/2	10	40
805-020	2		
805-025	2-1/2		
805-030	3	6	0
805-040	4	5	0

REDUCING TEE (SOC × SOC × SOC)

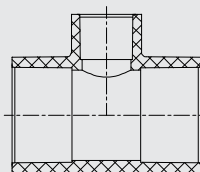

Part Number	Size (in)	Std PK	Mstr Ctn
801-101	3/4x3/4x1/2	15	120
801-130	1x1x1/2	15	90
801-131	1x1x3/4	15	90
801-168	1-1/4x1-1/4x1	15	60
801-210	1-1/2x1-1/2x3/4		
801-211	1-1/2x1-1/2x1		
801-247	2x2x1/2	10	60
801-248	2x2x3/4	10	60
801-249	2x2x1	10	60
801-250	2x2x1-1/4	10	40
801-251	2x2x1-1/2	10	40
801-290	2-1/2x2-1/2x1-1/4	10	40
801-291	2-1/2x2-1/2x1-1/2	9	36
801-292	2-1/2x2-1/2x2	9	36
801-337	3x3x1-1/2	10	0
801-338	3x3x2	10	0
801-420	4x4x2	5	0
801-422	4x4x3	5	0
801-530	6x6x3	3	0
801-532	6x6x4	4	0
801-585	8x8x6	5	0

90° EII (SOC × SOC)

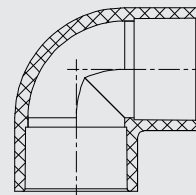

Part Number	Size (in)	Std PK	Mstr Ctn
806-002	1/4	50	600
806-003	3/8	20	240
806-005	1/2	25	300
806-007	3/4	20	160
806-010	1	25	100
806-012	1-1/4	10	60
806-015	1-1/2	15	60
806-020	2	8	32
806-025	2-1/2	5	30
806-030	3	5	20
806-040	4	5	0
806-060	6	4	0
806-080	8	4	0

90° EII (SOC × FIPT)

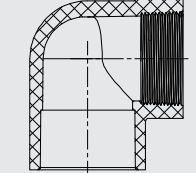

Part Number	Size (in)	Std PK	Mstr Ctn
807-005	1/2	20	240
807-007	3/4	25	200
807-010	1	25	100
807-012	1-1/4	10	60
807-015	1-1/2	10	40
807-020	2	15	60

TEE (SOC × SOC × FIPT)

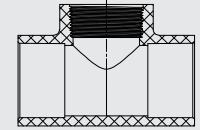

Part Number	Size (in)	Std PK	Mstr Ctn
802-005	1/2	20	120
802-007	3/4		
802-010	1	15	60
802-015	1-1/2	10	40
802-020	2	5	20

90° EII (FIPT × FIPT)

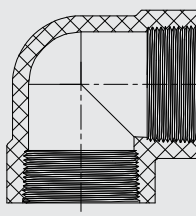

Part Number	Size (in)	Std PK	Mstr Ctn
808-002	1/4	50	600
808-003	3/8	50	600
808-005	1/2	20	240
808-007	3/4	25	200
808-010	1	15	90
808-012	1-1/4	10	60
808-015	1-1/2	10	40
808-020	2		
808-025	2-1/2	6	36
808-030	3	5	20
808-040	4	20	0

REDUCING TEE (SOC × SOC × FIPT)

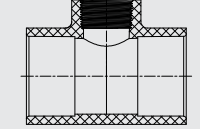

Part Number	Size (in)	Std PK	Mstr Ctn
802-251	2x2x1-1/2	10	40
802-291	2-1/2x2-1/2x1-1/2	10	40

45° EII (SOC×SOC)

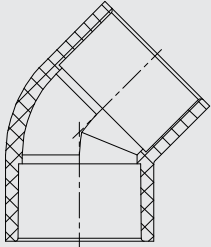

Part Number	Size (in)	Std PK	Mstr Ctn
817-002	1/4	50	600
817-003	3/8	25	300
817-005	1/2	30	360
817-007	3/4	20	240
817-010	1	20	120
817-012	1-1/4	15	90
817-015	1-1/2		
817-020	2	10	40
817-025	2-1/2	60	0
817-030	3	4	16
817-040	4	9	0
817-060	6	2	0

COUPLING (FIPT×FIPT)

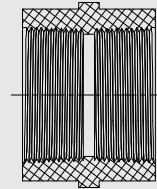

Part Number	Size (in)	Std PK	Mstr Ctn
830-002	1/4	50	600
830-005	1/2	25	300
830-007	3/4	25	300
830-010	1	15	180
830-012	1-1/4	10	120
830-015	1-1/2	10	80
830-020	2		
830-025	2-1/2	5	20
830-030	3	5	20
830-040	4	8	32

45° EII (FIPT×FIPT)

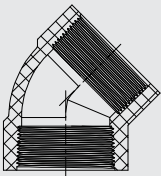

Part Number	Size (in)	Std PK	Mstr Ctn
819-005	1/2	30	360
819-007	3/4	20	240
819-010	1		
819-012	1-1/4	10	80
819-015	1-1/2	10	60
819-020	2	10	40
819-025	2-1/2	8	48
819-030	3	6	24
819-040	4	8	0

FEMALE ADAPTER (SOC×FIPT)

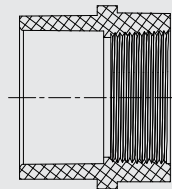

Part Number	Size (in)	Std PK	Mstr Ctn
835-002	1/4	50	600
835-005	1/2	30	360
835-007	3/4	30	240
835-010	1	25	150
835-012	1-1/4	10	120
835-015	1-1/2	10	80
835-020	2	15	60
835-025	2-1/2		
835-030	3	7	42
835-040	4	5	20

COUPLING (SOC×SOC)

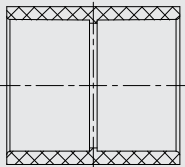

Part Number	Size (in)	Std PK	Mstr Ctn
829-002	1/4	50	600
829-005	1/2	35	420
829-007	3/4	25	300
829-010	1	25	150
829-012	1-1/4	10	80
829-015	1-1/2	10	80
829-020	2	10	60
829-025	2-1/2	10	60
829-030	3	25	0
829-040	4	12	0
829-060	6	4	0
829-080	8	6	0
829-100	10	8	0
829-120	12	1	0

MALE ADAPTER (MIPT×SOC)

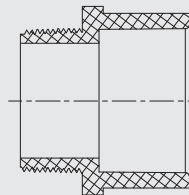

Part Number	Size (in)	Std PK	Mstr Ctn
836-005	1/2	25	300
836-007	3/4	25	300
836-010	1	20	160
836-012	1-1/4	10	120
836-015	1-1/2		
836-020	2	10	60
836-025	2-1/2	6	36
836-030	3	8	48
836-040	4	4	16

REDUCING COUPLING (SOC×SOC)

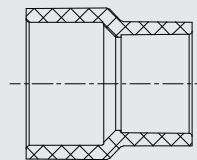

Part Number	Size (in)	Std PK	Mstr Ctn
829-101	3/4x1/2	50	300
829-130	1x1/2	25	150
829-131	1x3/4	25	150
829-166	1-1/4x1/2	25	150
829-167	1-1/4x3/4	25	150
829-168	1-1/4x1	35	140
829-210	1-1/2x3/4	25	100
829-211	1-1/2x1		
829-212	1-1/2x1-1/4	20	80
829-251	2x1-1/2	20	120
829-338	3x2	5	20
829-422	4x3	10	40
829-532	6x4	4	0
829-585	8x6	4	0

PVC SCHEDULE 80 FITTINGS



REDUCING BUSHING FLUSH STYLE (SPIG × SOC)

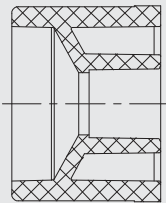

Part Number	Size (in)	Std PK	Mstr Ctn
837-052	3/8x1/4	100	1200
837-072	1/2x1/4	100	1200
837-073	1/2x3/8	50	600
837-101	3/4x1/2	50	600
837-130	1x1/2	50	400
837-131	1x3/4	50	400
837-166	1-1/4x1/2	50	300
837-167	1-1/4x3/4	50	300
837-168	1-1/4x1	25	200
837-209	1-1/2x1/2	30	180
837-210	1-1/2x3/4	30	180
837-211	1-1/2x1	25	150
837-212	1-1/2x1-1/4	25	150
837-247	2x1/2	25	150
837-248	2x3/4	10	120
837-249	2x1	10	120
837-250	2x1-1/4	10	120
837-251	2x1-1/2	10	120
837-289	2-1/2x1	10	60
837-290	2-1/2x1-1/4		
837-291	2-1/2x1-1/2	10	60
837-292	2-1/2x2		
837-335	3x1	10	40
837-337	3x1-1/2	10	40
837-338	3x2	10	40
837-339	3x2-1/2	10	40
837-420	4x2	6	24
837-421	4x2-1/2	6	24
837-422	4x3"	6	24
837-528	6x2	9	0
837-530	6x3	6	0
837-532	6x4	9	0

REDUCING T.T. BUSHING FLUSH STYLE (MIPT × FIPT)

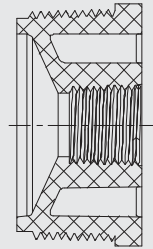

Part Number	Size (in)	Std PK	Mstr Ctn
839-072	1/2x1/4	100	1200
839-073	1/2x3/8	100	1200
839-098	3/4x1/4	100	1200
839-099	3/4x3/8	100	1200
839-101	3/4x1/2	50	600
839-129	1x3/8	50	600
839-130	1x1/2	50	600
839-131	1x3/4	50	600
839-166	1-1/4x1/2	35	420
839-167	1-1/4x3/4	25	300
839-168	1-1/4x1	25	300
839-210	1-1/2x3/4	25	200
839-211	1-1/2x1	25	200
839-212	1-1/2x1-1/4		
839-247	2x1/2	10	120
839-292	2-1/2x2	10	60

REDUCING BUSHING FLUSH STYLE (SPIG × FIPT)

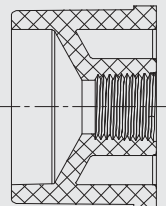

Part Number	Size (in)	Std PK	Mstr Ctn
838-052	3/8x1/4	100	1200
838-072	1/2x1/4	100	1200
838-101	3/4x1/2	50	600
838-130	1x1/2	50	400
838-131	1x3/4	50	400
838-166	1-1/4x1/2	25	300
838-167	1-1/4x3/4	20	240
838-168	1-1/4x1	25	200
838-209	1-1/2x1/2	30	180
838-210	1-1/2x3/4	25	150
838-211	1-1/2x1	25	150
838-212	1-1/2x1-1/4	25	150
838-247	2x1/2	10	120
838-248	2x3/4	10	120
838-249	2x1	10	120
838-250	2x1-1/4	10	120
838-251	2x1-1/2	10	120
838-292	2-1/2x2	10	60
838-338	3x2	10	40
838-339	3x2-1/2	10	40
838-420	4x2	6	24
838-422	4x3	6	24
838-532	6x4	6	0

CAP (SOC)

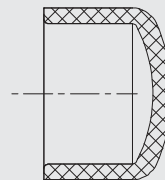

Part Number	Size (in)	Std PK	Mstr Ctn
847-002	1/4	100	1200
847-003	3/8	50	600
847-005	1/2	65	780
847-007	3/4	40	480
847-010	1	20	240
847-012	1-1/4	10	120
847-015	1-1/2	10	120
847-020	2	10	80
847-025	2-1/2	15	60
847-030	3	5	20
847-040	4	5	20
847-060	6	4	0
847-080	8	12	0

CAP (FIPT)

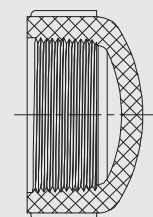

Part Number	Size (in)	Std PK	Mstr Ctn
848-002	1/4	100	1200
848-003	3/8	50	600
848-005	1/2	50	600
848-007	3/4	40	480
848-010	1	20	240
848-012	1-1/4	10	120
848-015	1-1/2		
848-020	2	10	60
848-025	2-1/2	10	60
848-030	3	8	32
848-040	4	5	20

PVC SCHEDULE 80 FITTINGS



PLUG (SPIG)

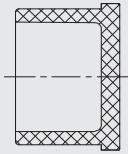

Part Number	Size (in)	Std PK	Mstr Ctn
849-010	1	50	300
849-020	2	10	120

WYE (SOC X SOC X SOC)

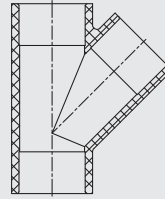

Part Number	Size (in)	Std PK	Mstr Ctn
875-020	2		
875-040	4	3	0
875-060	6	2	0

PLUG (MIPT)

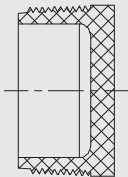

Part Number	Size (in)	Std PK	Mstr Ctn
850-002	1/4	100	1200
850-003	3/8	100	1200
850-005	1/2	150	1800
850-007	3/4	100	1200
850-010	1	50	600
850-012	1-1/4	30	360
850-015	1-1/2		
850-020	2	10	120
850-025	2-1/2	10	60
850-030	3	10	60
850-040	4	8	32

REDUCING NIPPLE (MIPTxMIPT)

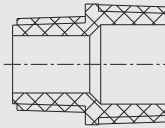

Part Number	Size (in)	Std PK	Mstr Ctn
882-249	3/4x1/2	50	600

FLANGE ONE PIECE (SOC)

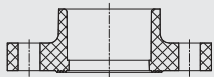

Part Number	Size (in)	Std PK	Mstr Ctn
851-025	2-1/2	15	0
851-030	3	12	0

UNION W/O-RING SEAL (SOCxSOC)

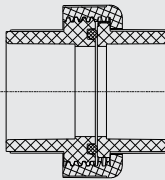

Part Number	Size (in)	Std PK	Mstr Ctn
897-002	1/4	25	300
897-005	1/2	10	120
897-007	3/4	20	120
897-010	1	10	80
897-012	1-1/4	10	40
897-015	1-1/2	5	30
897-020	2	10	40
897-030	3	5	20

FLOOR FLANGE (FIPT)

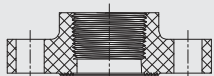

Part Number	Size (in)	Std PK	Mstr Ctn
852-005	1/2	20	120
852-007	3/4	25	150
852-010	1	15	60
852-012	1-1/4	15	60

UNION W/O-RING SEAL (FIPTxFIPT)

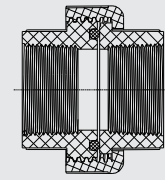

Part Number	Size (in)	Std PK	Mstr Ctn
898-005	1/2	20	160
898-007	3/4	20	120
898-010	1	10	80
898-012	1-1/4	10	60
898-015	1-1/2	10	40

BLIND FLANGE



Part Number	Size (in)	Std PK	Mstr Ctn
853-025	2-1/2	25	0
853-030	3	20	0

UNION W/O-RING SEAL (SOCxFIPT)

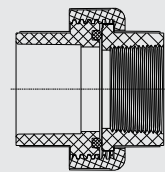

Part Number	Size (in)	Std PK	Mstr Ctn
899-005	1/2	20	160
899-007	3/4	20	120
899-010	1	10	80
899-012	1-1/4	15	60
899-015	1-1/2	10	40
899-020	2	5	30



## LIMITED WARRANTY

Except as otherwise mandated by law, LESSO America warrants to Buyer only that the Products directly manufactured by LESSO America will be free from defects in material and workmanship for a period of three years from the date of installation. Buyer agrees that this warranty shall be effective so long as the Products are used solely for the normal purposes for which they are intended and in conformity with industry established engineering, installation, operating, and maintenance specifications, recommendations and instructions. Violation thereof shall void this warranty and relieve LESSO America from any obligation under this warranty.

LESSO America may modify at any time design of products or materials used therein or discontinue their manufacture without any liability.

LESSO America shall not assume responsibility, and expressly disclaims any liability, due to Buyer's, any installer's or end user's failure to comply with such specifications, recommendations and instructions, including, but not limited to, damage due to improper control of system hydraulics, improper winterization procedures, improper voltage supply, contact with incompatible materials or chemicals, excavation/digging, excessive weight, temperature shocking, U.V.degradation, vibration and vandalism. LESSO America shall not be liable for damages due to any acts of nature including, but not limited to, lightning, earthquakes, ground movement, frost heave, floods, or any other event of force majeure.

Buyer shall notify LESSO America of any alleged defects within 48 hours of discovery of any alleged defect and within three years' warranty period. LESSO America is not liable for any warranty claim if such notice is not provided. After the examination of the returned products, if the goods are determined to be defective in materials or workmanship directly provided by LESSO America, LESSO America will, at its sole option, may either repair or replace the defective Products, or reimburse Buyer for the cost of such Products. This shall be Buyer's only remedy. All costs of shipping such questionable Products and any replacements thereof to and from LESSO America's facility shall be borne by Buyer.

THIS LIMITED WARRANTY REPLACES ALL OTHER ORAL OR WRITTEN WARRANTIES, LIABILITIES OR OBLIGATIONS OF LESSO America . THIS WARRANTY MAY NOT BE EXTENDED, ALTERED OR OTHERWISE MODIFIED EXCEPT BY WRITTEN AGREEMENT SIGNED BY COMPANY. BY ITS ACCEPTANCE OF THE PRODUCTS, CUSTOMER HEREBY SPECIFICALLY AND EXPRESSLY WAIVES ALL OTHER LIABILITY OR OBLIGATION OF ANY KIND OR CHARACTER OF COMPANY, INCLUDING WITHOUT LIMITATION LIABILITY PREDICATED UPON STRICT LIABILITY OR TORT, AND ALL DAMAGES AND LOSSES AS A RESULT THEREOF, INCLUDING BUT NOT LIMITED TO ALL KNOWN, UNKNOWN, FORESEEABLE, UNFORESEEABLE, ABSOLUTE, CONTINGENT, LIQUIDATED, NON-LIQUIDATED, COMPENSATORY, GENERAL, SPECIAL, CONSEQUENTIAL, INCIDENTAL, OR PUNITIVE DAMAGES, AND WITH RESPECT TO THE PRODUCTS, THEIR RETURN, REPAIR, RESTORATION AND REPLACEMENT.

Buyer agrees that LESSO America will not be responsible for other parts or labor in connection with repairing, replacing, or returning such Products while Products are in possession of LESSO America for analysis, nor for any delays beyond LESSO America's reasonable control(including, with limitation, delays due to unavailability of materials, equipment, other supplies or labor, strikes, governmental regulation etc.), provided that any delay shall toll the warranty period for the same amount of time as the delay itself. In no event shall LESSO America be liable for consequential or incidental damages of any kind, including any damage to any property, building, its contents or any person therein, resulting from the breach of this warranty.

## TERMS AND CONDITIONS OF SALE

- 1 ) Terms: 2% 30 days, Net 45 days.
- 2 ) Freight: FOB LESSO America warehouses.  
  
Schedule 80 products alone:  
Prepaid on orders for fittings totaling \$1200 net for one shipment to a single destination within the contiguous United States.  
  
Mixed product shipment: (ABS DWV, Schedule 40, 80 and PVC DWV)  
Prepaid on orders for fittings totaling \$1200 net for one shipment to a single destination within the contiguous United States.
- 3 ) Minimum order is \$150.00 net. Smaller orders will be billed at this minimum charge.
- 4 ) Any claims on shipping errors must be made within 15 days to LESSO America. Claims for damage or shortages should be directed to the common carrier by the consignee.
- 5 ) Returns will be accepted only by prior authorization and will be shipped prepaid. All returned merchandise is subject to a minimum 20% handling/ restocking charge.
- 6 ) All pricing is subject to change without prior notice.
- 7 ) Offer to sell is not implied by possession of this price list or any LESSO America catalog.

# LESSO

## CHINA LESSO GROUP HOLDINGS LIMITED

(Hong Kong Listed Stock Code: 2128)

[www.lesso.com](http://www.lesso.com)

---

### **LESSO AMERICA, INC.**

Add: 1010 Railroad Street, Corona, CA, 92882 United States

Tel: (951) 547-6888 Fax: (951) 547-6886

Toll free: (888) 988-8839 Web: [www.lessoamerica.com](http://www.lessoamerica.com)

---

\* LESSO America is affiliated with China LESSO Group Holdings Limited and is not affiliated with any third party companies, including LASCO or LASCO Fittings, Inc.

\* This catalog has been prepared as a support guide. Under no circumstance shall LESSO America assume any liability or responsibility with the information in this catalog. Every effort has been made by LESSO America to provide accurate and up to date information.

---

All Rights Reserved Apr. 2017  
Printed in China (HC)